

**AUX**



**AUX**

Artware in Air Conditioner

# Artisan Essence

Simple · Fashion  
Comfortable · Healthy  
Convenient · Efficient  
Safe · Reliable

All upgrading in 2018

## J-Smart

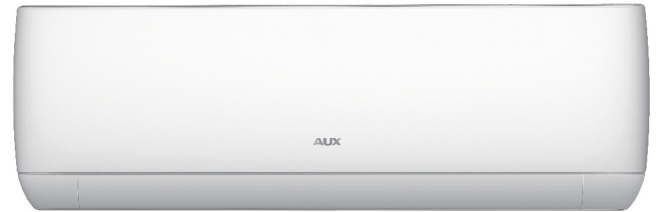

**No.1**

Matte finish panel  
0.3mm, Perfect Fit As One  
Inside corresponds to outside

# Artisan Essence

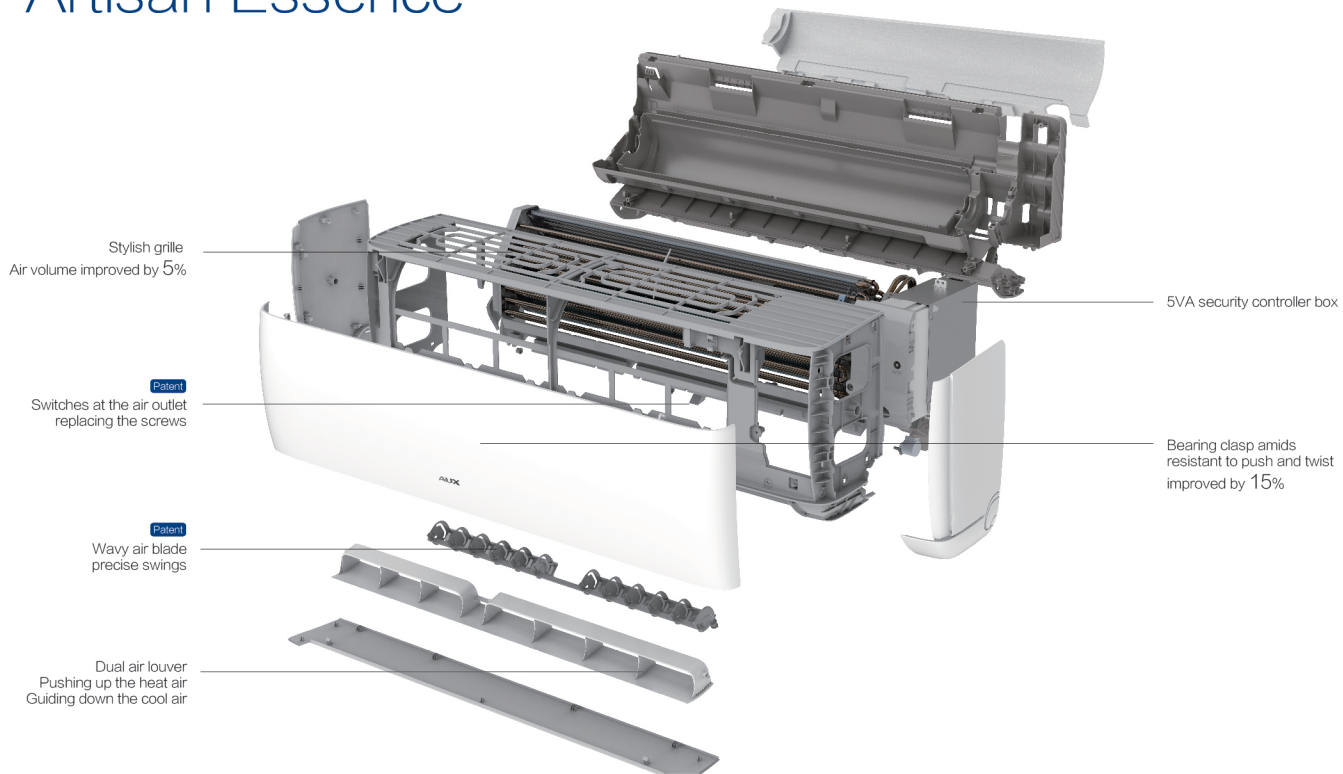

### Smart light (in development)

Adjust display and air speed by sensing the environment, lowering the noise level for better sleep.



### Anti-PM2.5

Remove 99.9% of PM 2.5 by electrostatic ion.

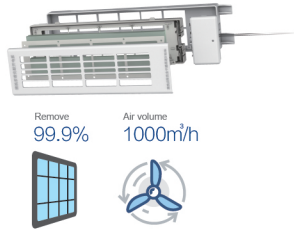

### Quick Cooling/Heating

Fast Cooling in 30s / Powerful heating in 1min, bringing comfort in time.

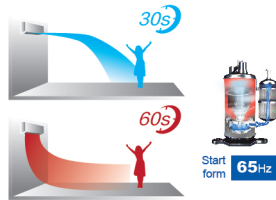

### -35°C ~60°C Comfortable running

With the leading two-stage compression (EVI) and cooling system optimization technology and high reliable unit components to ensure the reliable operation even in extreme ambient temperature (heating at -35°C ,cooling at 60°C )

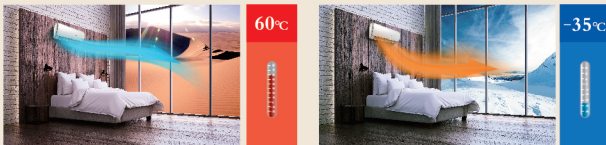

### Demountable Underjaw <sup>Patent</sup>

Installation engineers decreased from 2 or 3 to 1

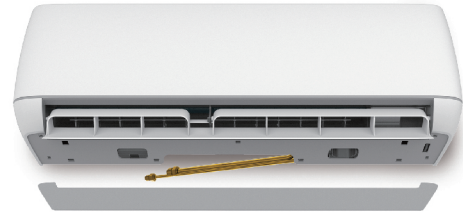

Engineer to 1



Installation time reduced by half

### WIFI-2.0

USB wifi, easy for installation with high efficiency and convenience.

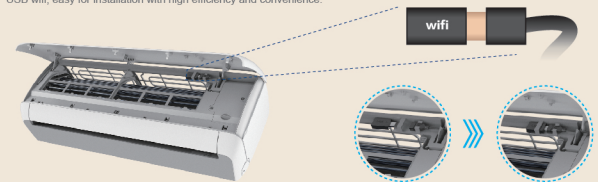

### Fins- design air louver <sup>Patent</sup>

Less air resistance , 10% longer air supply distance

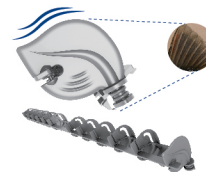

### Wave position buckle <sup>Patent</sup>

Reliable and precise air supply.

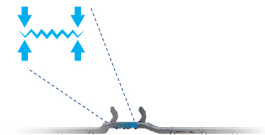



### New Inverter System

1Hz+0.1°C+0.3W



1Hz operation



0.1°C temperature control



0.3W stand by

### Fluoride leakage protection **Patent**



### Lower to 130V

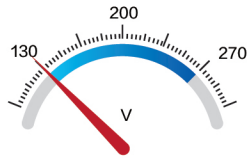

Super Compressor(130~270V)

### 5VA security controller box



### Cover for the valves



### Self-Cleaning Plus **Patent**

Heat exchanger starts the auto cleaning by frosting and defrosting, preventing bacteria inside and bringing more healthier air



### Multiple protection

multiple protections to prevent insects, mice, dust and damping

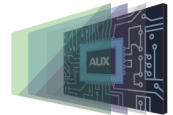
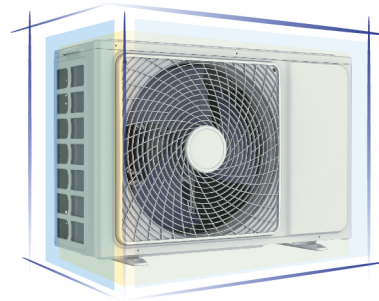

- Prevent Dust
- Prevent Moisture
- Prevent Short Circuit



- Prevent Insects
- Prevent Fire

## New ODU Appearance **Patent**

The design of external grille is upgraded. The guide vane at certain angles effectively brings the improvement in heat dissipation by 30%, anti-extreme temperature attenuation by 20% when the ODU are facing close obstacles ( $\leq 200\text{cm}$ )

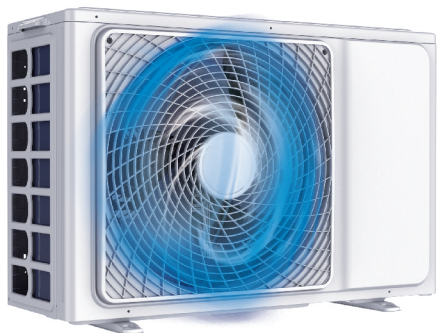

**30%**  
Heat dissipation capability

## Intelligent Defrost **Patent**

Automatically start defrosting according to temperature changes



Energy saving  
**▲ 5%**



Heating under low-temperature  
**▲ 20%**

# J-Smart

ASIA

Middle East

Europe

America

**SEER 18** **CSPF 5.93**

**EER 8 STAR**

**SCOP 5.1** **SEER 8.5**

**SEER 28** **HSPF 9.5**

Model		9K	12K	15K	18K	24K
Cooling Capacity	Btu/h	9000	12000	15000	18000	24000
Heating Capacity	Btu/h	9900	13200	16500	19800	26400
Noise Level	dB(A)	28/30/33	30/32/35	33/35/37	33/38/39	35/39/43
<b>Net Dimension&amp;Net Weight</b>						
Indoor	mm	792*292*201	881*294*194	940*316*224	997*316*227	1132*330*232
Outdoor	mm	660 × 500 × 240	730 × 545 × 285	785 × 550 × 295	800 × 545 × 315	900 × 700 × 350
Net Weight(Indoor/Outdoor)	Kg	8/24	10.5/28	11/33	14/38	16/46
<b>loading QTY</b>						
Loading QTY		40H	291	234	219	193

