

# Owner's Manual

---

## **SPLIT TYPE FLOOR STANDING AIR-CONDITIONER**

Please pay attention to the following:

- ※ The installation should be carried out by specialists.
- ※ In order to use it safely, correctly and efficiently, please read the instructions carefully and keep the instructions for reference in the future.
- ※ Make sure of grounding connection of the air-conditioner.

### **AUX AIR CONDITIONER CO.,LTD.**

1166 North Mingguang Road, Jiangshan, Yinzhou, Ningbo,  
315191 Zhejiang, China

## Operation and maintenance

<b>Safety precautions</b> .....	1
<b>Notices for use</b> .....	5
<b>Names of each part</b> .....	6
<b>Operation manual of the control panel</b> .....	7
<b>Clean and care</b> .....	8
<b>Troubleshooting</b> .....	10

## Installation service

<b>Notices for installation</b> .....	12
<b>Install indoor unit</b> .....	15
<b>Install outdoor unit</b> .....	18
<b>Check after installation and test operation</b> .....	21

**Note: All the pictures in this manual are just schematic diagrams. the actual is the standard.**

## Check after installation

- Electric safety inspection
  1. Grounding check: Check that the grounding line is earthed securely.
  2. Electric leakage check (performed during the test run): During the test run after the installation of the air conditioner, the installers may check with an electric pen or multimeter the housing and other areas where electric leakage may occur, and, if there is indeed electric leakage, immediately stop the unit and carry out further inspection to determine the cause, and, if the installation problems are the culprit, resolve the problems before another test run, until the air conditioner runs safely and normally.
- Leak test of the refrigerant
 

Depending on the installation method, the following methods may be used to check for suspect leak, on areas such as the four connections of the outdoor unit and the cores of the cut-off valves and t-valves:

  1. Bubble method: Apply of spray a uniform layer of soap water over the suspected leak spot and observe carefully for bubble.
  2. Instrument method: Checking for leak by pointing the probe of the leak detector according to the instruction to the suspect points of leak.

## Test operation

- Make sure that pipes and wires are connected.
- Make sure that liquid side valve and air side valve both are completely open.
- Connect the wire to independent power source socket.
- Preparation of remote controller.
- Run the air-conditioner in cooling operation mode for 30 minutes or longer.
- Test the out and in air temperature.
- Make sure whether the outlet air temperature subtract from inlet's gives more than 10°C.

## Waste disposal

- After installation of the product, please don't throw away the waste (such as packaging materials), which shall be placed at the rubbish dump.
- When the product is damaged or replaced, please submit the waste to the professional recycling agency for disposal.

## Expelling the air

### ●Outdoor unit refrigerant discharging method

After the pipe side connection is complete, proceed as follows.

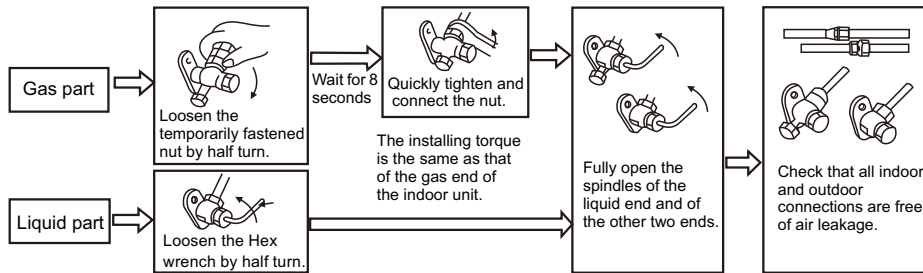

### ●Vacuum pumping method (R410A refrigerant evacuation must use the vacuum pumping method)

Before working on the air conditioner, remove the cover of the stop valve(gas and liquid valves)and be sure to retighten it afterward.(to prevent the potential air leakage)

1. To prevent air leakage and spilling tighten all connecting nut of all flare tubes.
2. Connect the stop valve, charge hose, manifold valve, and vacuum pump.
3. Fully open the handle Lo of the manifold valve and apply vacuum for at least 15 minutes and check that the compound vacuum gauge reads -0.1MPa(-76cmHg).
4. After applying vacuum, fully open the stop valve with a hex wrench.
5. Check that both indoor and outdoor connections are free of air leakage.

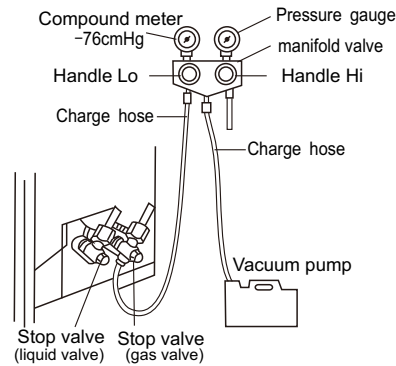

## Outdoor condensation drainage(Heat pump type only)

When the unit is heating, the condensing water and defrosting water can be out reliably through the drain house.

### Installation:

Install the outdoor drain elbow in  $\Phi 25$  hole on the base plate, and joint the drain hose to the elbow, so that the waste water formed in the outdoor unit can be drained out to a proper plate.

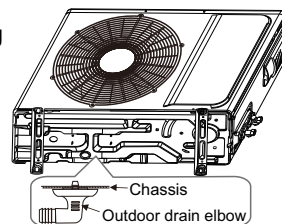

Incorrect installation or operation by not following these instructions may cause harm or damage to people, properties, etc.  
The seriousness is classified by the following indications:

### WARNING ⚠

This symbol indicates the possibility of death or serious injury.

### CAUTION ⚠



This symbol indicates the possibility of injury or damage to properties.

### WARNING ⚠

**This appliance can be used by children aged from 8 years and above and persons with reduced physical, sensory or mental capabilities or lack of experience and knowledge if they have been given supervision or instruction concerning use of the appliance in a safe way and understand the hazards involved. Children shall not play with the appliance. Cleaning and user maintenance shall not be made by children without supervision.**  
**(Only for the AC with CE-MARKING)**

**This appliance is not intended for use by persons (including children) with reduced physical, sensory or mental capabilities, or lack of experience and knowledge, unless they have been given supervision or instruction concerning use of the appliance by a person responsible for their safety. Children should be supervised to ensure that they do not play with the appliance.**  
**(Except for the AC with CE-MARKING)**

# Safety precautions

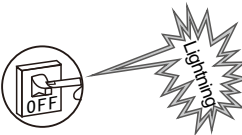
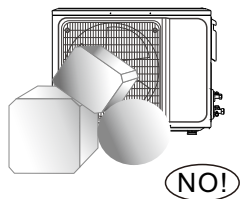
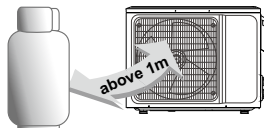
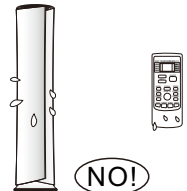
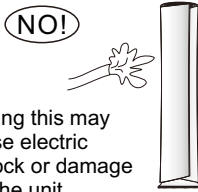
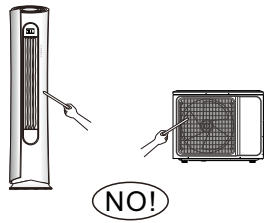
<p><b>The air conditioner must be grounded. Incomplete grounding may result in electric shocks.</b></p>  <p>Do not connect the earth wire to the gas pipeline, water pipeline, lightning rod, or telephone earth wire.</p>	<p><b>Cut off the main power switch when the unit is not in use for long time so as to ensure safety.</b></p> 	<p><b>Don't use air conditioner in lightning storm weather.</b></p>  <p>Power supply should be cut in time to prevent the occurrence of danger.</p>
<p><b>Don't block air inlet or air outlet.</b></p>  <p>Otherwise, the cooling or heating capacity will be weakened, even cause system stop operating.</p>	<p><b>Don't install air conditioner in a place where there is flammable gas or liquid. The distance between them should above 1m.</b></p>  <p>It may cause fire.</p>	<p><b>Take care not let the remote control and the indoor unit watered or being too wet.</b></p>  <p>Otherwise, it may cause short circuit even fire.</p>
<p><b>Don't use liquid or corrosive cleaning agent wipe the air conditioner and sprinkle water or other liquid either.</b></p>  <p>Doing this may cause electric shock or damage to the unit.</p>	<p><b>Don't put hands or any objects into the air inlets or outlets.</b></p>  <p>This may cause personal injury or damage to the unit.</p>	<p><b>An earth leakage breaker with rated capacity must be installed to avoid possible electric shocks.</b></p> <p><b>The appliance shall be installed in accordance with national wiring regulations.</b></p>

# Install outdoor unit

## Wiring connection

1. Loosen the screws and remove E-parts cover from the unit.
2. Connect the cables respectively to the corresponding terminals of the terminal board of the outdoor unit (see the wiring diagram), and if there are signals connected to the plug, just conduct butt joint.
3. Ground wire: Remove the grounding screw out of the electric bracket, cover the grounding wire end onto the grounding screw and screw it into the grounding hole.
4. Fix the cable reliably with fasteners (Pressing board).
5. Put the E-parts cover back in its original place and fasten it with screws.

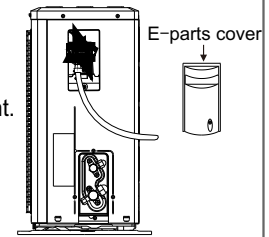

## Wiring diagram

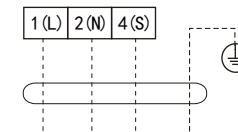

**Note:** The diagram are for reference only. If the entity is difference with this wiring diagram, please refer to the detailed wiring diagram adhered on the unit which you purchased.

## Dimension drawing of outdoor unit installation

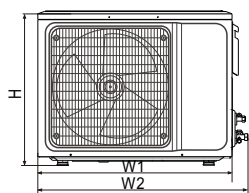
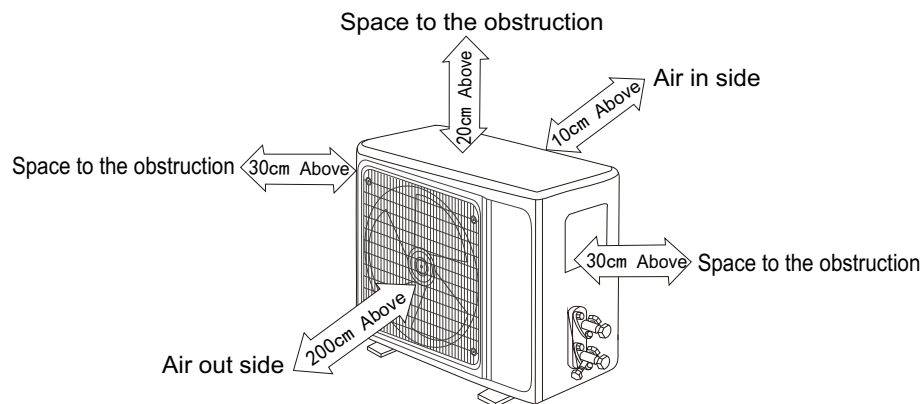

### Installation outdoor unit bolt

Outdoor Unit Size of Shape W1(W2)*H*D) (mm)	A (mm)	B (mm)
800(860)×545×315	545	315
800(850)×(690)×310	540	325
900(950)×700×350	630	350
900(950)×795×330	535	350

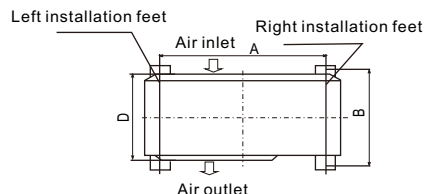

## Install the connection pipe

Connect the Outdoor Unit with Connection Pipe: Aim the counter-bore of the connection pipe at the shut off valve, and tighten the Taper nut with fingers. Then tighten the Taper nut with a torque wrench until the wrench makes a "click" sound.

### ★ Piping Length and Height

The maximum piping length (m)	Maximum height difference (m)
25	6

**Note:** If the pipe length is greater than 5m but is less than 25m, add refrigerant according to 20g/m.

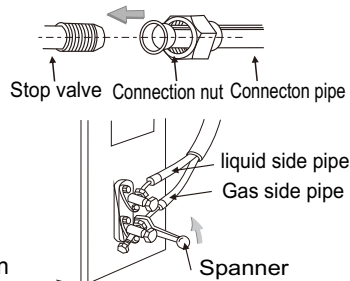

Regarding the installation of the air conditioners, please refer to the below paragraphs in this manual.

**This product contains fluorinated greenhouse gases.**

Refrigerant leakage contributes to climate change. Refrigerant with lower global warming potential (GWP) would contribute less to global warming than a refrigerant with higher GWP, if leaked to the atmosphere. This appliance contains a refrigerant fluid with a GWP equal to [2088]. This means that if 1 kg of this refrigerant fluid would be leaked to the atmosphere, the impact on global warming would be [2088] times higher than 1 kg of CO<sub>2</sub>, over a period of 100 years. Never try to interfere with the refrigerant circuit yourself or disassemble the product yourself and always ask a professional.

The specification of the fuse are printed on the circuit board, such as: 5A/250V AC, etc.

## WEEE Warning

**Meaning of crossed out wheeled dustbin:**  
Do not dispose of electrical appliances as unsorted municipal waste, use separate collection facilities.

Contact you local government for information regarding the collection systems available. If electrical appliances are disposed of in landfills or dumps, hazardous substances can leak into the groundwater and get into the food chain, damaging your health and well-being.

**When replacing old appliances with new ones, the retailer is legally obligated to take back your old appliance for disposals at least free of charge.**



## CAUTION

**Don't open the windows and doors for long time when the air conditioner is running.**

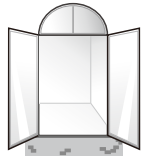

Otherwise, the cooling or heating capacity will be weakened.

**Don't stand on the top of the outdoor unit or place heavy things on it.**

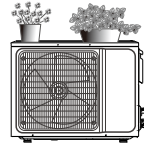

NO!

This could cause personal injuries or damage the unit.

**Don't use the air conditioner for other purposes, such as drying clothes, preserving foods, etc.**

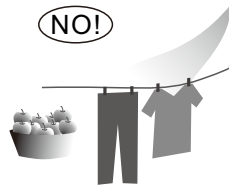

NO!

**Don't apply the cold air to the body for a long time.**

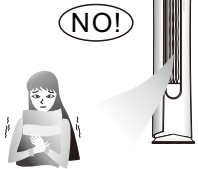

It will deteriorate your physical conditions and cause health problems.

**Set the suitable temperature.**

It is recommended that the temperature difference between indoor and outdoor temperature should not be too large.

Appropriate adjustments of the setting temperature can prevent the waste of electricity.

**If your air conditioner is not fitted with a supply cord and a plug, an all-pole switch must be installed in the fixed wiring and the distance between contacts should be no less than 3.0 mm.**

**If your air conditioner is permanently connected to the fixed wiring, a residual current device (RCD) having rated residual operating current not exceeding 30 mA should be installed in the fixed wiring.**

**If the supply cord is damaged, it must be replaced by the manufacturer, its service agent or similarly qualified persons in order to avoid a hazard.**

**The power supply circuit should have leakage protector and air switch of which the capacity should be more than 1.5 times of the maximum current.**

## Install the curtain holders(optional)

- When install the air conditioner near the curtains, please install the curtain holders to prevent the curtains from adhering to the air inlet.
- Pick up the curtain holders (2) from the accessory kit.
- When install the curtain holders, please click the clasp into the slot of the unit, and fasten it.

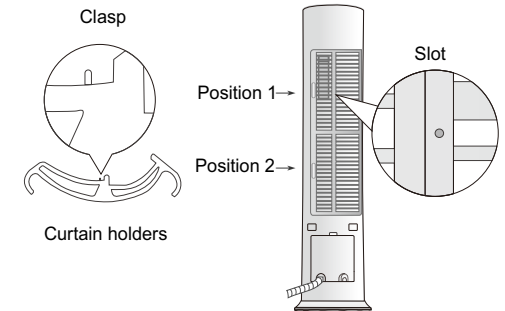

## Install an Anti-tip Chain(optional)

- To prevent the air conditioner from tipping over, it is advised to install an Anti-tip Chain.

**The procedure is as follows:**

1. Remove the screw from the anti-tip hole in the top cover of the indoor unit.
2. Pick up the Anti-tip Chain from the accessory kit and put one end into the anti-tip hole, then fasten it with the screw.
3. Fasten the other end with another screw onto the wall.

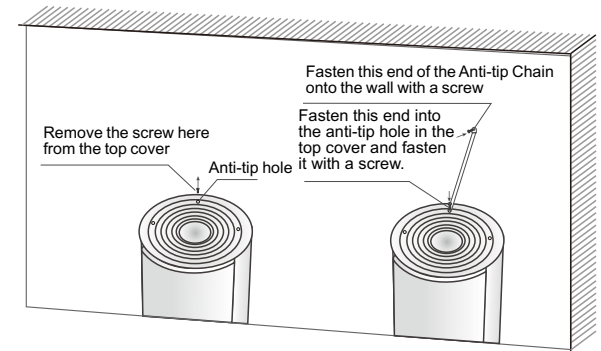

The components in the diagram above may not be exactly the same as the physical ones.

## Wiring diagram

1. Unscrew the screws that fix the control box and remove the control box cover.
2. Install the power cable according to the wiring diagram of the unit. Tighten the screws that fix the wires, and then gently pull the wires to ensure the tightness.
3. Finally, install the control box cover and tighten the screws.

**Note:** In some models, connecting wires inside the electric control box have been connected in the factory, while in the rest models, the connecting wires are not connected. The clients may need to connect it by themselves. Please connect the wire according to the wiring diagram on the controller box cover of indoor unit.

## Drain pipe connection

1. The drain pipe shall be tilted from inside to outside in order to drain the condensate water easily.
2. The joint shall be tightened, and its indoor part shall be wrapped with thermal insulation material.
3. Properly route the connection pipe, power cable, signal connection cable and drain pipe when wrapping, to avoid the concave-convex of drain pipe.

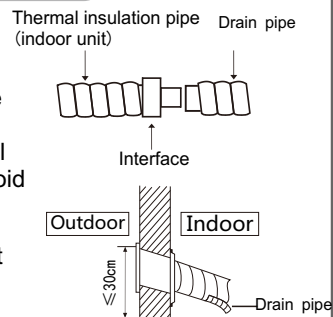

**Note:** After the drain pipe out of the wall, the outdoor part shall not be higher than the wall hole, i.e. not higher than 30cm, to avoid the backflow of condensate water.

## Install the connection pipe

Uncoil the connection pipe, and bend the connection pipe according to your required length, unscrew the nuts of the pipe of the indoor unit, align the conical joint of connection pipe with the center of the corresponding pipe of indoor unit, tighten the nut by hand, and then tighten it again with torque wrench. The torques used are shown in the following table:

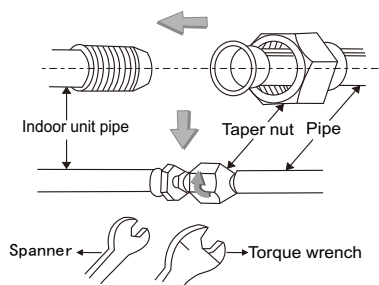

**Tightening torque table**

The size of pipe(mm)	Torque(N · m)
Φ6/Φ6.35	15~25
Φ9.52	35~40
Φ12/Φ12.7	45~60
Φ15.88	73~78
Φ19.05	75~80

**Note:** Firstly connect the connection pipe to indoor unit. then to outdoor unit; pay attention to the bending, do not damage the connection pipe; the joint nut couldn't lighten too much, otherwise it may cause leakage.

## The conditions of unit can't normally run

- \* Within the temperature range provided in following table, the air conditioner may stop running and other anomalies may arise.

Cooling	Outdoor	>43°C(Apply to T1)
	Indoor	>52°C(Apply to T3)
Heating	Outdoor	<18°C
	Indoor	>24°C <-7°C >27°C

- \* When the temperature is too high, the air conditioner may activate the automatic protection device, so that the air conditioner could be shut down.
- \* When the temperature is too low, the heat exchanger of the air conditioner may freeze, leading to water leakage or other malfunction.
- \* In long-term cooling or dehumidification with a relative humidity of above 80% (doors and windows are open), there may be water condenses or dripping near the air outlet.
- \* T1 and T3 refer to ISO 5151.

## Notes for heating

- \* The fan of the indoor unit will not start running immediately after the heating is started to avoid blowing out cool air.
- \* When it is cold and wet outside, the outdoor unit will develop frost over the heat exchanger which will compromise the heating capacity. This is when the air conditioner will start defrost.
- \* During defrost, the air conditioner will stop heating for about 5-12 minutes.
- \* Vapor may come out from the outdoor unit during defrost. This is not a malfunction, but a result of fast defrost.
- \* Heating will resume after defrost is complete.

## Notes for ambient temperature display

- \* To prolong the useful life of the compressor, the AC controller will turn ON/OFF the compressor automatically according to the actual conditions, and it is normal that the unit may not be turned off immediately after the ambient temperature reaches the set temperature, but after a delay.
- \* As the temperature is not uniform throughout the room, the air conditioner will make compensation automatically to improve the comfort, it is normal that the temperature displayed is not the same as measured by the user.

## Notes for turning off

- \* When the air conditioner is turned off, the main controller will automatically decide whether to stop immediately or after running for dozens of seconds with lower frequency and lower air speed.

## Indoor unit

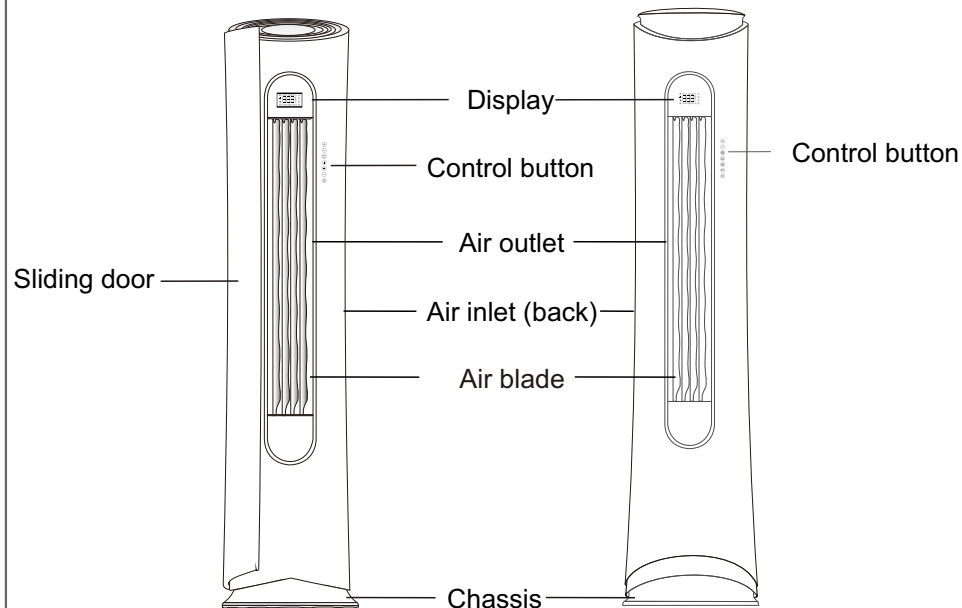

## Outdoor unit

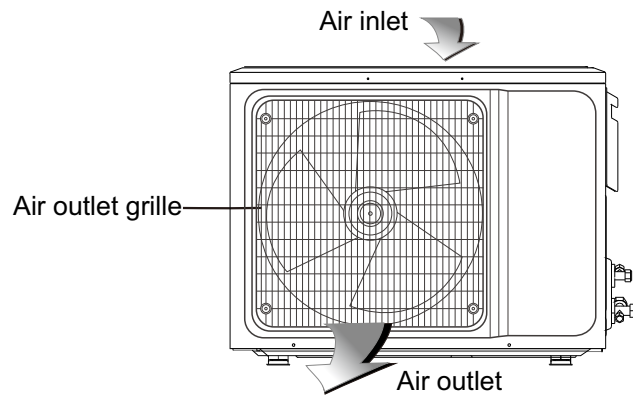

**Note: All the pictures in this manual are just schematic diagrams, the actual is the standard.**

## Dimension drawing of indoor unit installation

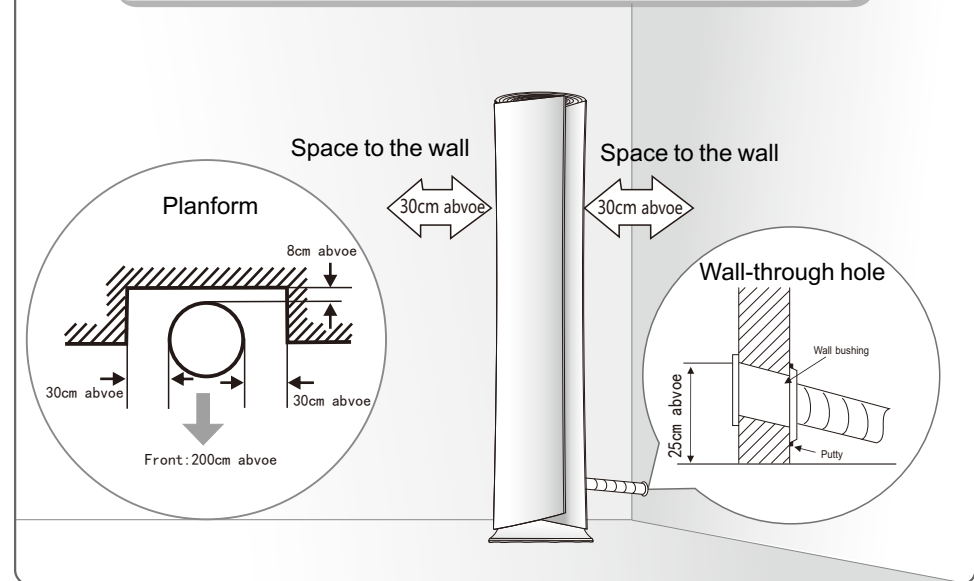

## Wall-through hole

1. The wall-through hole shall slant outwardly by 5°-10°.
2. To protect the piping and the cables from being damaged running through the wall, and from the rodents that may inhabit in the hollow wall, a pipe protecting ring shall be installed and sealed with putty.
3. The distance between the highest position of wall hole and the bottom of air conditioner shall not be more than 30cm to prevent the unit from leakage.

## Installation procedure

1. Unscrew the screws that fix the back cover, remove the back cover, and cut off the outlet cutting-stocks. 2 optional outlets as shown in the figure, please select proper outlet location according to the actual need.
2. Install the connection pipe, wire and drain pipe, and then wrap them up together with tape.
3. Route the power cord separately from the pipeline and through the corresponding hole. When running out the wrapped pipe, please cut off the cutting stock of the hole as shown in the figure. Install the back cover and fix it tightly with screws.
4. Move the indoor unit to the wall or the corner to ensure easy installation and removing of curtain holders and air filter.

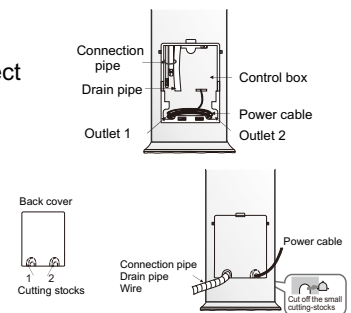



## Others

- The connection method of the air conditioner and the power cord and the interconnection method of each independent element shall be subject to the wiring diagram affixed to the machine.
- The model and rating value of the fuse shall be subject to the silkscreen on corresponding controller or fuse sleeve.
- The auxiliary electric heater belongs to ceramic PTC electrical heating element, the rated power of which is subject to the data on the nameplate affixed on the machine.
- If the auxiliary electric heater, PTC, or the protections, if damaged, shall be replaced by professionals with spare parts provided by the Company.

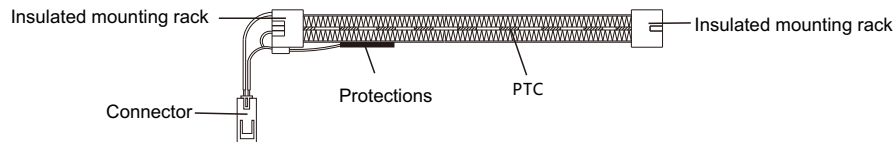

- Note:** 1. The figure is for reference only, subject to the installed indoor unit.  
2. Some models don't have auxiliary electric heater function. This part instruction is only for the models with auxiliary electric heater function.

## Packing list

### Packing list of the indoor unit

Name	Quantity
Indoor unit	1 Set
Remote controller	1 PC
Batteries (7#)	2 PC
Instructions	1 Set
Drain pipe	1 PC
Curtain holders/ anti-fall chain (*)	1 Set

### Packing list of the outdoor unit

Name	Quantity
Outdoor unit	1 Set
Connection pipe(*)	2 PC
Plastic strap	1 ROLL
Pipe protection ring	1 PC
Luting (putty)	1 PACKET

**Note:** Optional parts(\*), some models without.

**Note:** All accessories shall be subject to actual packaging material, and if there is any difference, please understand.

## Display

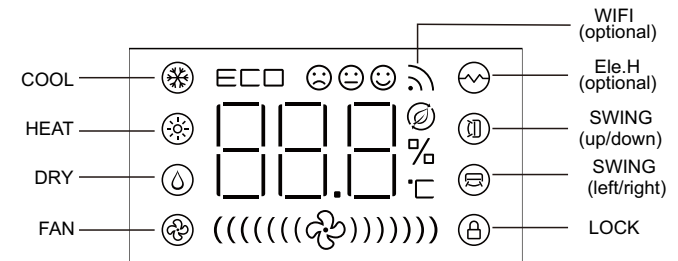

## Control button



- \* For the purpose of temperature setting, each time the " ^ " (" v ") is pressed, the setting will increase(decrease) by 0.5°C.
- \* The temperature setting can be quickly adjusted by keeping pressing this button. The temperature setting range is 16°C-32°C.
- Note: The TEMP button is invalid in fan mode.**
- \* For the purpose of fan speed setting, each time the " ^ " (" v ") is pressed, the fan speed will increase(decrease) by 1%; Keeping pressing this button enables quick adjustment.

- \* Press this button to select the fan speed or temperature settings.
- Note: The TEMP button is invalid in fan mode.**

- \* Press the button to activate up/down (right/left) swing function and press it again to fix the swing position.
- \* With the memory function for the air swing, the original setting will remain valid after the unit is turned off and on again.

- \* Press this button, the running mode will change as below:  
[COOL→DRY→HEAT→FAN]

- \* Press this button to turn ON/OFF the air conditioner.
- \* The original settings of time, sleeping and other functions will be cleaned up after the unit is turned ON/OFF.
- Note: This button should be pressed for at least 0.2s to avoid misoperation.**

## ⚠ Caution

- Before the cleaning of the air conditioner, it must be shut down and the electricity must be cut off for more than 5 minutes, otherwise there might be the risk of electric shocks.
- Do not wet the air conditioner, which can cause an electric shock. Make sure not to rinse the air conditioner with water under any circumstances.
- Volatile liquids such as thinner or gasoline will damage the air conditioner housing, therefore please clean the housing of air conditioner only with soft dry cloth and damp cloth moistened with neutral detergent.
- In the course of the using, pay attention to cleaning the filter regularly, to prevent the covering of dust which may affect the effect. If the service environment of the air conditioner is dusty, correspondingly increase the number of times of cleanings.
- After removing the filter, do not touch the fin part of the indoor unit with the finger, so as to avoid scratching it.

## Clean the panel

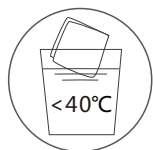

Wash the cloth with water



Wring out it

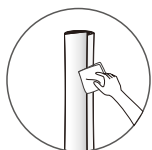

Wipe the surface of the unit

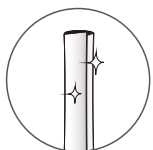

**Warm tip:** Regular wiping can maintain a clean and good appearance of the air conditioner.

## Clean the air filter

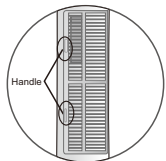

Find the handler

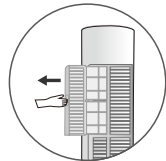

Grab the filter at the handle and pull it out



Take off the air filter

## Requirements of the mounting structure

- The mounting rack must meet the relevant national or industrial standards in terms of strength with welding and connection areas rustproofed.
- The mounting rack and its load carry surface shall be able to withstand 4 times or above the weight of the unit, or 200kg, whichever is heavier.
- The mounting rack of the outdoor unit shall be fastened with expansion bolt.
- Ensure the secure installation regardless of what type of wall on which it is installed, to prevent potential dropping that could hurt people.

## Electrical safety requirements

- Be sure to use the rated voltage and air conditioners dedicated circuit for the power supply, and the power cord diameter must meet the national requirements.
- When the maximum current of air conditioner is  $\geq 16\text{A}$ , it must use the air switch or leakage protection switch equipped with protection devices.
- The normal operating range is 90%-110% of the local rated voltage.
- The minimum clearance between the air conditioner and the combustibles is 1.5 m.

## Grounding requirements

- The air conditioner is the type I electrical appliance and must ensure a reliable grounding.
- Do not connect the grounding wire to a gas pipe, water pipe, lightning rod, telephone line, or a circuit poorly grounded to the earth.
- The grounding wire is specially designed and shall not be used for other purpose, nor shall it be fastened with a common tapping screw.

## ⓘ Important notices

- Before installing, please contact with local authorized maintenance center, if unit is not installed by the authorized maintenance center, the malfunction may not solved, due to discommodious contact.
- The air conditioner must be installed by professionals according to the national wiring rules and this manual.
- To move and install air conditioner to another place, please contact our local special service center.

## Requirements for installation position

- Avoid places of inflammable or explosive gas leakage or where there are strongly aggressive gases.
- Avoid places subject to strong artificial electric/magnetic fields.
- Avoid places subject to noise and resonance.
- Avoid severe natural conditions (e.g. heavy lampblack, strong sandy wind, direct sunshine or high temperature heat sources).
- Avoid places within the reach of children.
- Shorten the connection between the indoor and outdoor units.
- Select where it is easy to perform service and repair and where the ventilation good.
- The outdoor unit shall not be installed in any way that could occupy an aisle, stairway, exit, fire escape, catwalk or any other public area.
- The outdoor unit shall be installed as far as possible from the doors and windows of the neighbors as well as the green plants.

## Requirements for operations at raised height

- When carrying out installation at 2m or higher above the base level, safety belts must be worn and ropes of sufficient strength be securely fasten to the outdoor unit, to prevent falling that could cause personal injury or death as well as property loss.



Clean the air filter



Dry the air filter

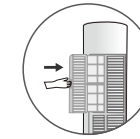

Reinstall the air filter

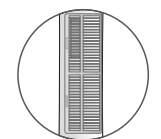

**Warm tip:** Clean the filter twice a week to ensure a healthy environment and energy saving effect.

## Check before use

1. Check whether all the air inlets and outlets of the units are unblocked.
2. Check whether there is blocking in the water outlet of the drain pipe, and immediately clean it up if any.
3. Check the ground wire is reliably grounded.
4. Check whether the remote control batteries are installed, and whether the power is sufficient.
5. Check whether there is damage in the mounting bracket of the outdoor unit, and if any, please contact our local service center.

## Maintain after use

1. Cut off the power source of the air conditioner, turn off the circuit breaker and remove the batteries from the remote control.
2. Clean the filter and indoor and the outdoor unit body.
3. Remove the dust and debris from the outdoor unit.
4. Check whether there is damage in the mounting bracket of the outdoor unit, and if any, please contact our local service center.

## ⚠ Caution

\* Do not repair the air conditioner by yourself as wrong maintenance may cause electric shock or fire, please contact the authorized service center and let the professionals conduct the maintenance, and checking the following items prior to contacting for maintenance can save your time and money.

Phenomenon	Troubleshooting
The air conditioner does not work.	<ul style="list-style-type: none"> <li>• There might be power outages. → Wait until power is restored.</li> <li>• Power plug may be loose out from the socket. → The plug in the plug tightly.</li> <li>• Power switch fuse may blow. → Replace the fuse.</li> <li>• The time for timing boot is yet to come. → Wait or cancel the timer settings.</li> </ul>
The air conditioner can't run after the immediate start-up after it is shut down.	<ul style="list-style-type: none"> <li>• If the air conditioner is turned on immediately after it is turned off, the protective delay switch will delay the operation for 3 to 5 minutes.</li> </ul>
The air conditioner stops running after it starts up for a while.	<ul style="list-style-type: none"> <li>• May reach the setting temperature. → It is a normal function phenomenon.</li> <li>• May be at a defrosting state. → It will automatically restore and run again after defrosting.</li> <li>• Shutdown Timer may be set. → If you continue to use, please turn it on again.</li> </ul>
The wind blows out, but the cooling/heating effect is not good.	<ul style="list-style-type: none"> <li>• Excessive accumulation of dust on filter, blocking at air inlet and outlet, and the excessively small angle of the louver blades all will affect the cooling and heating effect. → Please clean the filter, remove the obstacles at the air inlet and outlet and regulate the angle of the louver blades.</li> <li>• Poor cooling and heating effect caused by doors and windows opening, and unclosed exhaust fan. → Please close the doors, windows, the exhaust fan, etc.</li> <li>• Auxiliary heating function is not turned on while heating, which may lead to poor heating effect. → Turn on the auxiliary heating function. (only for models with auxiliary heating function)</li> <li>• Mode setting is incorrect, and the temperature and wind speed settings are not appropriate. → Please re-select the mode, and set the appropriate temperature and wind speed.</li> </ul>
The indoor unit blows out odor.	<ul style="list-style-type: none"> <li>• The air conditioner itself does not have undesirable odor. If there is odor, it may be due to accumulation of the odor in the environment. → Clean the air filter or activate the cleaning function.</li> </ul>

There is sound of running water during the running of air conditioner.	<ul style="list-style-type: none"> <li>• When the air conditioner is started up or stopped, or the compressor is started up or stopped during the running, sometimes the "hissing" sound of running water can be heard. → This is the sound of the flow of the refrigerant, not a malfunction.</li> </ul>
A slight "click" sound is heard at the of start-up or shut-down.	<ul style="list-style-type: none"> <li>• Due to temperature changes, panel and other parts will swell, causing the sound of friction. → This is normal, not a fault.</li> </ul>
The indoor unit makes abnormal sound.	<ul style="list-style-type: none"> <li>• The sound of fan or compressor relay switched on or off.</li> <li>• When the defrosting is started or stop running, it will sound. → That is due to the refrigerant flowed to reverse direction. They are not malfunctions.</li> <li>• Too much dust accumulation in the air filter of the indoor unit may result in fluctuation of the sound. → Clean the air filters in time.</li> <li>• Too much air noise when "Strong wind" is turned on. → This is normal, if feeling uncomfortable, please deactivate the "Strong wind" function.</li> </ul>
There are water drops over the surface of the indoor unit.	<ul style="list-style-type: none"> <li>• When ambient humidity is high, water drops will be accumulated around the air outlet or the panel, etc. → This is a normal physics phenomenon.</li> <li>• Prolonged cooling run in open space produces water drops. → Close the doors and windows.</li> <li>• Too small opening angle of the louver blades may also result in water drops at the air inlet. → Increase the angle of the louver blades.</li> </ul>
During the cooling operation, the indoor unit outlet sometimes will blow out mist.	<ul style="list-style-type: none"> <li>• When the indoor temperature and humidity are high, it happens sometimes. → This is because the indoor air is cooled rapidly. After it runs for some time, the indoor temperature and humidity will be reduced and the mist will disappear.</li> </ul>

## ⚠ Immediately stop all operations and cut off the power supply , contact our Service center locally in following situations.

- ▲ Hear any harsh sound or smell any awful odor during running.
- ▲ Abnormal heating of power cord and plug occurs.
- ▲ The unit or remote control has any foreign substance or water.
- ▲ Air switch or leakage protection switch is often disconnected.
- ▲ Fault code is displayed on the panel display of air conditioner: FA, Fb, F\*, E\*, P\*, L\* (\* represents the number 0 to 9).